

Unical®

TRIOPREX N.



TRIOPREX N: for high efficiencies and low emissions

TRIOPREX N is the Unical's answer for those that ask for a boiler with 3 effective smoke passages and high performances with reduced costs.

- High efficiency (> 91,5%)
- Low NOx values (< 120 mg/kWh)
- Conformity to the Standards EN 303 and 92/42/CE directive, that control the construction, the efficiency and the "low temperature" operation for the boilers.

The technical evolution of TRIOPREX N boilers completely satisfy the parameters required by the modern heating system technology.

- Approval with output range, means the possibility for a single model to operate at every load, included by the indicated range, always with high efficiencies.

- Compatibility with the boiler at low emissions, thanks to the 3 smoke passages, without flame reversing into the furnace.

Technical features

The boilers TRIOPREX N with 3 smoke passages are constituted by:

- a shell of oval shape
- a cylindrical furnace completely wet, where is developed the first smoke passage
- the pipes beam on the upper part, for the second and third smoke passage realization
- a special collector/distributor that, by optimizing the water circulation, correctly stratify the temperatures

The pipes beam is placed on the upper and hotter part of the boiler to reduce the temperature difference between the combustion gases and water, in order to avoid the condensation formation, beginning and cause of corrosion and rapid traditional boilers deterioration.

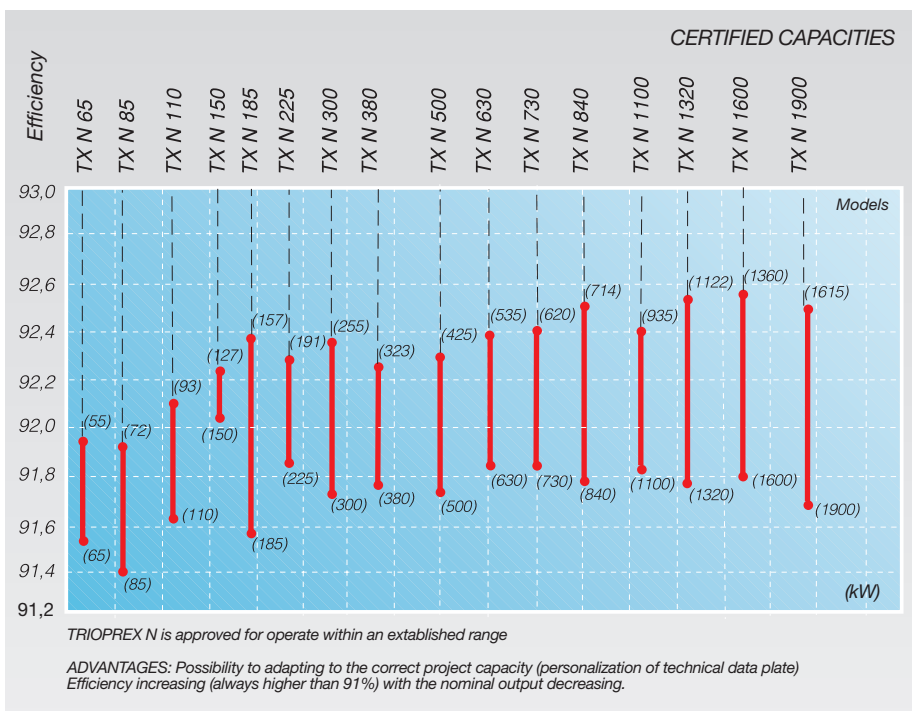

3 effective smoke passages

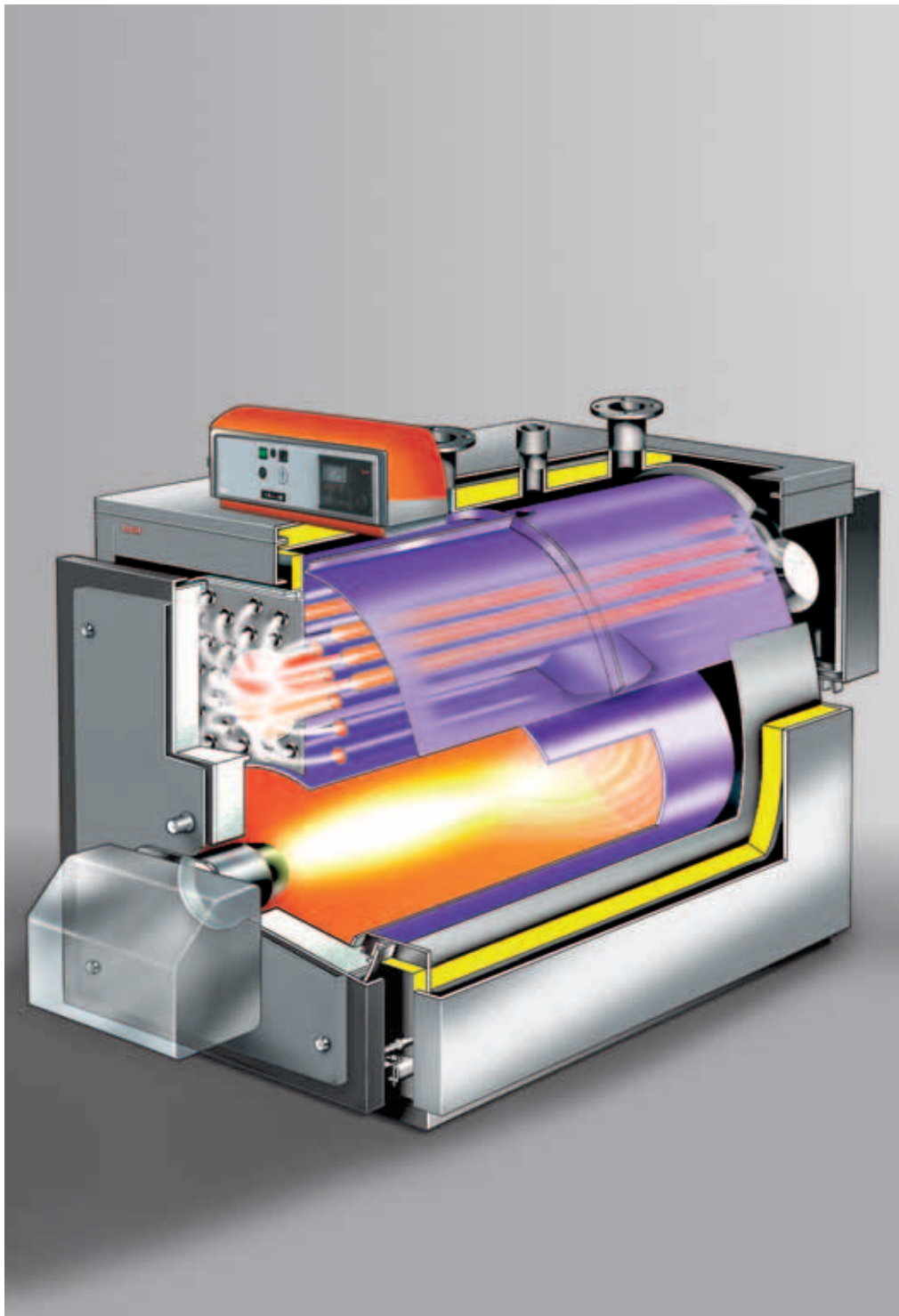

OVAL SHAPE SHELL DESIGN FOR SPACE SAVING INSTALLATION, UP TO 730 KW MODEL

CYLINDRICAL FURNACE FREE TO DILATE (1ST PASSAGE)

RETURN FURNACE PIPES WITH LARGE DIAMETER (2ND PASSAGE)

PIPES BEAM WITH HIGH THERMAL EXCHANGE (3RD PASSAGE)

HEAT EXCHANGE OPTIMIZATION BY MEANS OF THE DRIVEN WATER PASSAGE IN THE BOILER

SMOKE PIPES WITH LARGE THICKNESS WITH ANTI CONDENSING EFFECT

TURBOLATORS FOR HEAT EXCHANGE OPTIMIZATION INTO THE SMOKE PIPES

INSULATED SMOKE CHAMBER WITH DOUBLE WALL FOR ACOUSTIC AND THERMAL LOSSES REDUCTION

DOOR INSULATED WITH CERAMIC FIBRE (UP TO TX N 840) WITH AUTO LOCKING SYSTEM AT ELASTIC DEFORMATION (LONGER LIFE, - 30% RADIATION HEAT LOSSES)

FULL 80 MM THICK GLASS WOOL INSULATION UP TO MODEL TX N 85; 100 MM OF THICKNESS FOR BIGGER MODELS

PATENTED FIN EFFECT ON THE WELDING SEAMS OF PIPES ONTO THE REAR TUBE PLATE

SPECIAL CONTROL PANELS WITH THERMOSTATIC OR ELECTRONIC CONTROLS, AVAILABLE ALSO FOR CASCADE MANAGEMENT

RECOMMENDED FOR INSTALLATION WITH LOW NOX BURNERS

POSSIBLE OPERATION ALSO WITH HEAVY OIL (PLEASE, CONTACT UNICAL'S TECHNICAL OFFICE)

What are NOx ...

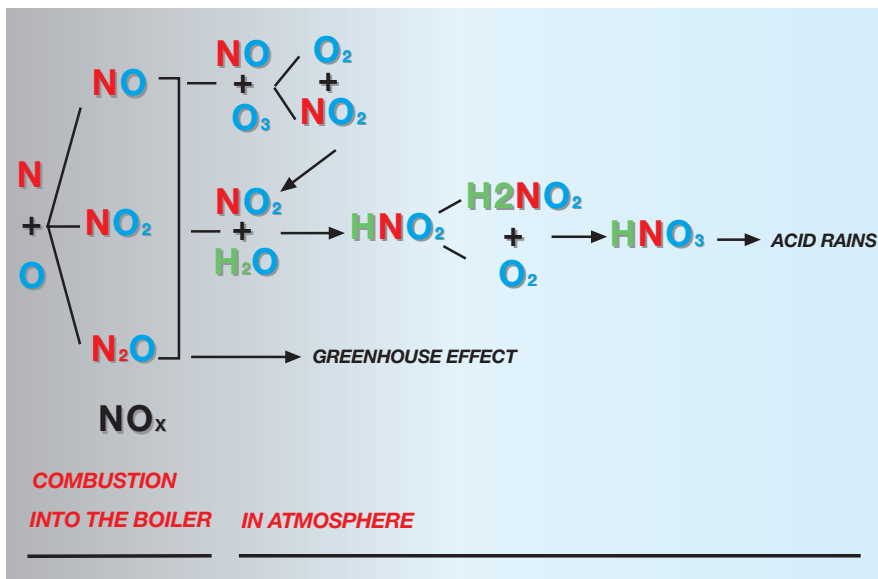

In the detail, the NO combination is the prevailing one inside the boiler (95% or more), while the NO₂ formation is significant only at low temperature, after the emission in atmosphere. For their origin, it's possible to distinguish three different NOx formation processes.

Thermal NOx

They are constituted by the nitrogen present into the combustion air with flame temperatures higher than 1300°C. Their concentration is directly proportional to the flame temperature, to the permanence time into the combustion gases high temperature zone, to the oxygen pressure in the same combustion zone.

NOx ready

They are constituted by the combination of molecular oxygen present in the combustion air with hydrocarbons, produced by the fuels dissociation during the first combustion phases. This mechanism particularly gets easier the NO formation. The pollutant quantity is directly proportional to the oxygen concentration, or rather to the air excess, not depending by the temperature.

NOx from fuel

They are constituted by the reaction of nitrogen organic compounds present into the fuel with the air oxygen at combustion temperatures higher than 1000°C. This formation mechanism of nitric oxides is present into the combustion of oil and carbon, not for natural gas, because the methane gas doesn't include nitrogen.

What are NOx?

The main atmospheric pollutants produced by the heating systems through the combustion are:

- dusts
- light hydrocarbons (C_x H_y)
- carbon monoxide
- sulphur oxide (SO_x)
- nitric oxide (NO_x)

Generally the presence and the concentration of these pollutants depend essentially by fuel, combustion quality and boiler and burner manufacturing features. The nitric oxides are the only pollutants that don't depend by the fuel choice, because they are mostly the result of nitrogen and oxygen combination present in the combustion air, with different procedures.

With the name "nitric oxides" and the formula NO_x, are normally indicated NO (nitric monoxide), NO₂ (nitrogen dioxide), N₂O (nitrous oxide).

... and how to reduce them

The NO_x formation mostly depends from the permanence time into the flame zone and from the air excess. Once constituted, the nitric oxides reach the atmosphere chemically reacting in a quite complicated way, still not very clear (photochemical reactions and reactions with steam).

The quantity of N₂O is stable and remains into the atmosphere for several years: with carbon dioxide CO₂ and other pollutants, contributes to the greenhouse effect.

The nitric monoxide (NO) is quickly converted in NO₂ and O₂, through reactions with ozone O₃.

Finally, the nitrogen dioxide (NO₂) is converted into nitrogen acid HNO₂ and further oxidation constitutes the nitric acid HNO₃, contributing, in this way, to the acid rains.

It's also important to remember that NO₂ is naturally and permanently present in the atmosphere, but with a very low concentration.

How to reduce them with TRIOPREX N

The NO_x formation process is strongly influenced by:

- Flame temperature
- Combustion gases permanence time into the high temperature zone;
- Oxygen concentration

The provisions to adopt are:

- Combustion temperature reduction;
- Thermal load reduction (kW/m³), working under the nominal capacity;
- Reduction of gas permanence time into the combustion chamber;
- Oxygen concentration reduction.

Unical, with TRIOPREX N, adopted the following manufacturing solutions in order to reduce the NO_x formation:

- *3 smoke passages without reversed flame into the furnace*
the furnace is no more with reversed

flame, but at direct crossing; the burner flame results as more compact and shorter, reducing in this way the permanence time into the high temperature zone; the flame reversion absence allows, furthermore, a better flame cooling by the wet surfaces;

- thermal load reduction

the combustion chamber volume was increased in comparison with standard 3 smoke passages boilers of the same capacity.

By adopting the modern low NO_x burners is possible to obtain an extra emissions reduction with:

- smoke recirculation (reburning), a part of combustion gases is involved again into the combustion process. In this way the oxygen pressure and the flame temperature are reduced.
- reduction of oxygen pressure, thanks to the air excess reduction.

A further NO_x control is obtained by reducing the burner output into the established range.

Less consumptions, more comfort

OIL

MINIMUM RETURN TEMPERATURE

at parted load of 30%

at full load 100%

36°C

GAS

MINIMUM RETURN TEMPERATURE

at parted load of 30%

at full load 100%

46°C

The operation at low temperature

The particular manufacturing technology used, characterised by the using of boiler height, with the accurate study of water circuit into the boiler, gives the possibility to adopt TRIOPREX N boilers down to a minimum return temperature of 36°C in case oil is used, and 46°C in case of gas use, both at full or parted load operations.

This opportunity allows, with an outer thermoregulation equipped with an outdoor sensor, to directly modulate the water temperature into the boiler. The operation with lower temperatures in all the load conditions, reduces both the heat losses through the jacket and the smokes, allowing a sensible fuel saving and, then, less polluting emissions.

UNIFORM TEMPERATURES DISTRIBUTION

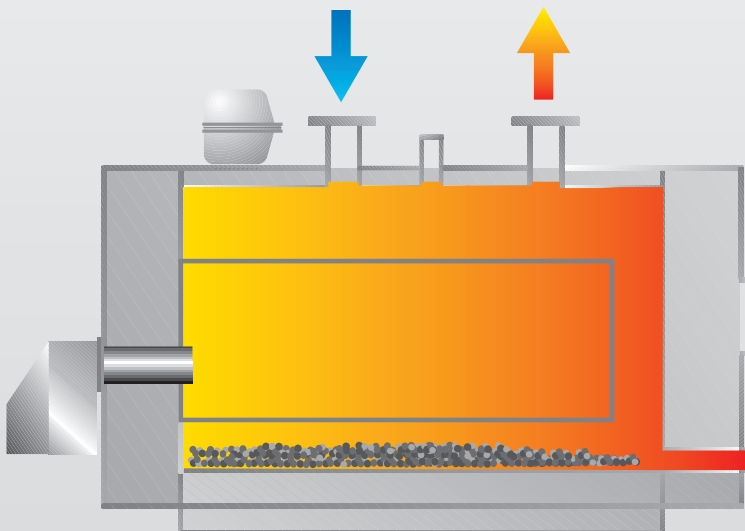

Vanguard technology for a long life

Long life time and thermal door insulation are the details that represent the “visiting card” of this boiler of high manufacturing quality and that guarantee duration and efficiency.

The front door

Particular attention was paid to the front door study because, in all the pressurized boilers, the door good quality is the necessary condition for a good operation. In fact, being the furnace under pressure, every minimum space should provoke an high temperature combustion gases loss, with gasket burning and door overheating.

For these reasons the door structure of TRIOPREX N is able to absorb every thermal or mechanical solicitation. Furthermore, the special internal insulation in *ceramic fibre* (up to the model TX N 840) let to reach the steady conditions in a shorter time, avoiding thermal chocks and drastically reducing the condensation formation during the ignition.

An interesting door detail is the autolocking system, realized by the steel support plates with elastic deformation that always allows the door correct position on the sealing gasket even if the ceramic fibre cord becomes hard.

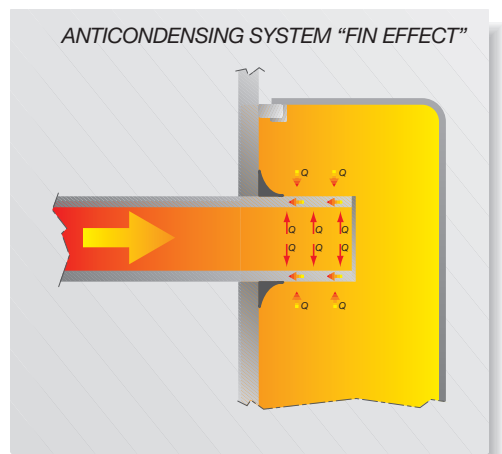

Fin effect

A further detail for acid condensations reduction and boiler life prolongation, particularly into the smoke pipes and in their welding to the rear pipe plate, is to prolong the pipe length over the plate itself. This solution causes a “fin effect” that redirects the heat to the welding, drying the condensation all around and avoiding its formation.

The insulation

Particular attention is given to the boiler insulation in order to reduce the passive heat losses to the

environment. For this reason between the boiler body and the casing is provided a glass wool insulation with high thickness (85 - 110 mm) at direct contact to the boiler.

The insulation is protected by the external casing constituted by steel plates painted with epoxy polyester no-toxic varnishes. An insulating interspace is also present in the rear smoke chamber.

Minimum space required



Boiler complete with burner (not included)

One of the targets reached during the development of TRIOPREX N boiler is to give a valid solution to the space problems that normally occur when is necessary to modernize the already existing heating systems.

In many cases the boilers have to be introduced in very small places and with difficult access.

The TRIOPREX N structure is vertical, with the pipe beam placed over the furnace: so the reduced dimensions in width make easier the passage through doors and narrow spaces.



WIDTH DIMENSIONS OF BOILER BODY WITHOUT THERMAL INSULATIONS (dimensions in mm)

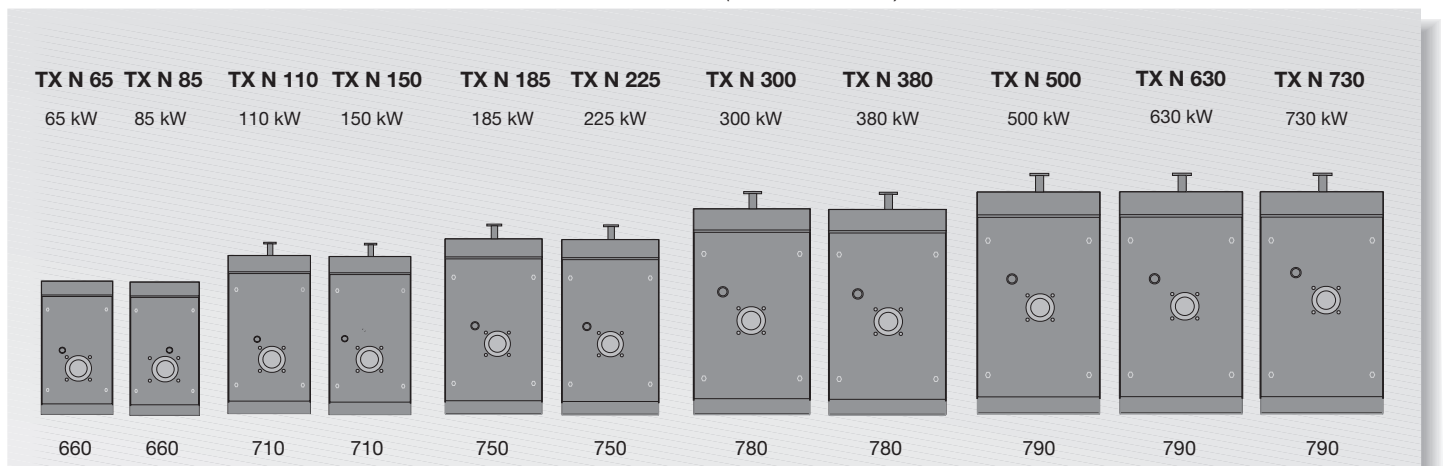

The control panel

The control panel has been developed in accordance with the current regulations and with the European Low Voltage Directive 73/23. On request, the control panel can be adapted to any configuration required by the heating system.

The standard control panel is equipped with: the mains switch for the system pump and burner, boiler thermometer, a 2 stage working thermostat, a safety thermostat and minimum temperature thermostat. On request, we can supply a electrical control panel fitted with a digital thermoregulator with relative boiler sensors, return connection, outdoor sensors (standard equipment) and room sensors (optional) model type 20316.

TRIOPREX N is supplied with a control panel model type 21057 which permits the adjustment of the burner, the pump and the water temperature.

For more complicated heating systems, electronic control panels with built-in thermoregulation (model type 21109) already installed and wired are available. These can control:

one direct zone C.H. system for without mixing valve, or a C.H. system for one zone with a motorized mixing valve, or two zone C.H. system: a direct one and one with a mixing valve (boiler sensor

for an external storage tank and return connection supplied together with the boiler).

On request it is possible to run 2 boilers in cascade.

Thermoregulation

The main features:

Self-adapting program:

this function, which is obtained only if the room temperature sensor is installed, permits the generator to adapt its working functions to the building's characteristics by means of an elaboration of the data received from the same thermoregulation. This function is proof of a constant monitoring of the internal temperature varied by the change in the outside temperature, taking into consideration the building's thermal inertia and the "free" heat contributions (solar radiation, internal heat sources, etc).

Optimization:

the thermoregulation, on the basis of the hours set by the user, and once analyzed the heating system's features, will proceed with more or less anticipation, to start-up the boiler or change the state of the flame, in order to ensure the right comfort temperature at the hour requested by the user.

Overheating protection:

the control of the generator's safety temperature mode is ensured through the post-functioning of the circulators in

order to dispose of any possible thermal inertia accumulated before shut-down in the furnace and in the flue pipes.

Exercise control of more than one zone:

with the same thermoregulation you can control 2 independent circuits with different features, even though ensuring all the described functions.

Domestic hot water production:

there are many programmes which control the DHW production. One can choose from the maximum comfort to the maximum economy. In order to rapidly reach steady boiler operation the thermoregulation brings the boiler temperature to the maximum set value.

Anti bacteria function:

the boiler temperature is brought to 60°C every 20 heating cycles or at least once a week on Saturday at 1.00. With this procedure any possible pathogens which could originate in the DHW are eliminated.

Programme setting:

the hours can be set daily or weekly with various ignitions and shut-downs during the space of the day.

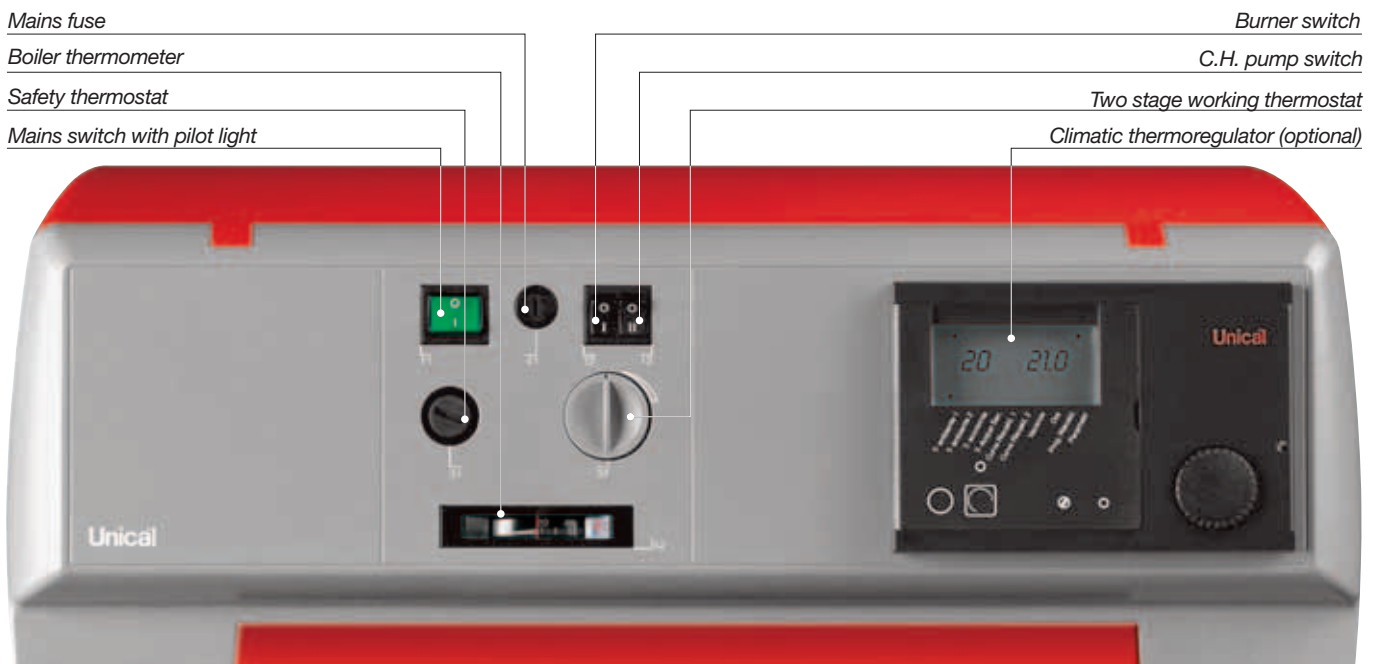

Dimensions

TRIOPREX N 65 and 85

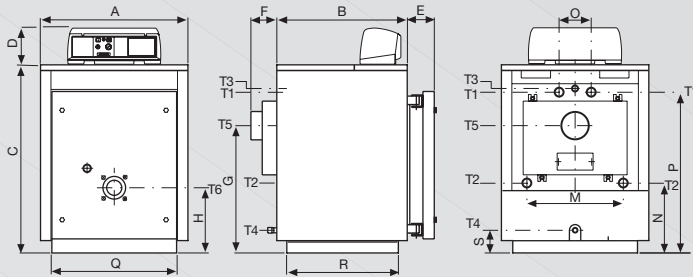

- Key:
- T1** - C.H. flow
 - T2** - C.H. return
 - T3** - Expansion vessel connection
 - T4** - Boiler drain
 - T5** - Chimney connection
 - T6** - Burner connection

TRIOPREX N 110÷380

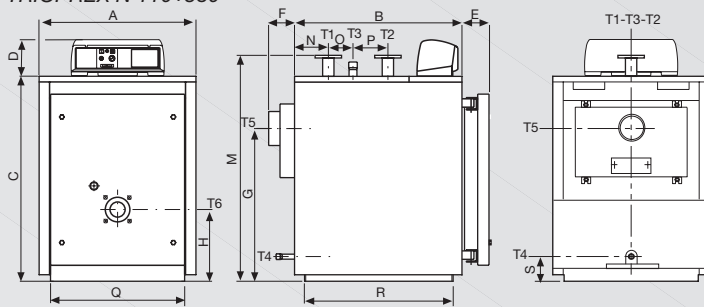

TRIOPREX N 500÷840

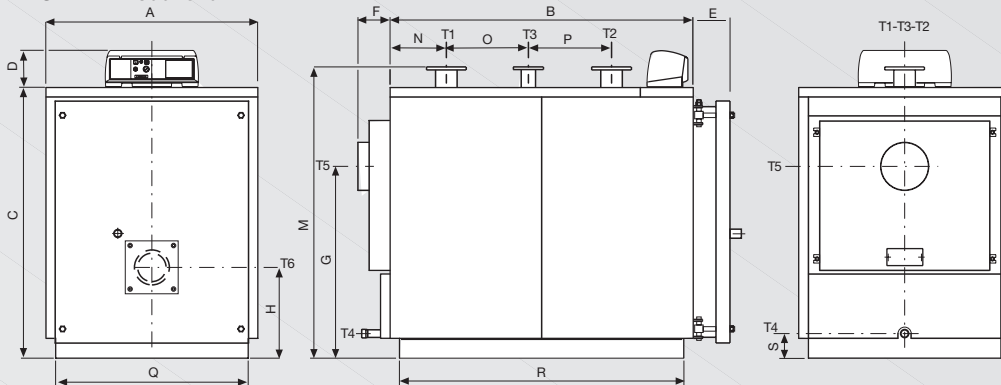

TRIOPREX N 1100÷1900

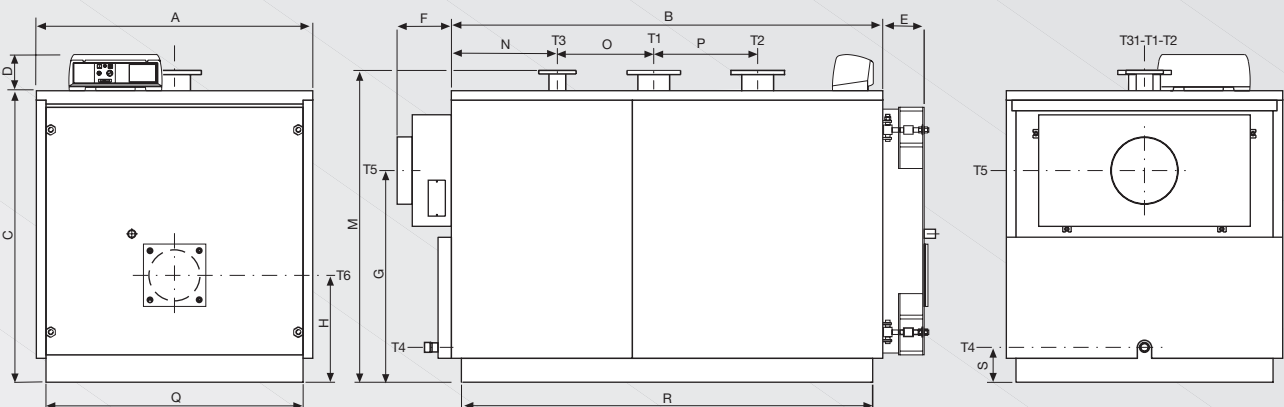

Technical data

TRIOPREX N	Output min/max	Input min/max	Water content	Water side pressure losses	Flue side pressure losses	Maximum working pressure	Combustion chamber volume	Weight
Model	kW	kW	l	w.c. m	w.c. mm	bar	m ³	kg
TX N 65	55÷65	59,8÷71	131	0,04÷0,06	3÷4	5	0,060	307
TX N 85	72÷85	78,3÷93	187	0,05÷0,07	4,5÷6	5	0,088	348
TX N 110	93÷110	101÷120	204	0,06÷0,08	5,5÷7,5	5	0,103	426
TX N 150	127÷150	137÷163	270	0,08÷0,10	12÷16	5	0,139	503
TX N 185	157÷185	170÷202	285	0,10÷0,18	9÷12	5	0,155	564
TX N 225	191÷225	207÷245	322	0,17÷0,20	12,5÷17,5	5	0,176	621
TX N 300	255÷300	276÷327	408	0,22÷0,35	9÷12	5	0,239	812
TX N 380	323÷380	350÷414	475	0,32÷0,53	15÷21	5	0,280	906
TX N 500	425÷500	460÷545	708	0,10÷0,15	25÷35	5	0,389	1295
TX N 630	535÷630	579÷686	794	0,16÷0,23	32÷45	5	0,443	1430
TX N 730	620÷730	671÷795	871	0,23÷0,33	35÷49	5	0,498	1560
TX N 840	714÷840	772÷915	932	0,35÷0,52	42÷58	5	0,542	1581
TX N 1100	935÷1100	1012÷1198	1580	0,15÷0,21	45÷62	6	0,753	2444
TX N 1320	1122÷1320	1214÷1438	1791	0,21÷0,30	61÷85	6	0,889	2965
TX N 1600	1360÷1600	1470÷1743	2297	0,20÷0,28	40÷55	6	1,116	3685
TX N 1900	1615÷1900	1745÷2070	2496	0,27÷0,39	52÷73	6	1,261	4089

* Hydraulic resistance for Δt 15 K

TRIOPREX N	A	B	C	D	E	F	G	H	M	N	O	P	Q	R	S	Connections				
																T1 T2 PN 16	T3 PN 16	T4 ISO 7/1	T5 Ø MM	T6 Ø MM
Model	MM	MM	MM	MM	MM	MM	MM	MM	MM	MM	MM	MM	MM	MM	MM	MM	MM	MM	MM	MM
TX N 65	740	690	950	190	140	145	660	345	470	310	190	846	660	588	120	Rp1 ^{1/2}	Rp1	Rp3 ⁴ / ₄	150	132
TX N 85	740	950	950	190	140	145	660	345	470	310	190	846	660	848	120	Rp1 ^{1/2}	Rp1	Rp3 ⁴ / ₄	150	132
TX N 110	830	885	1115	190	140	145	748	380	1210	175	130	185	710	786	130	DN50	Rp1 ^{1/4}	Rp3 ⁴ / ₄	180	132
TX N 150	830	1145	1115	190	140	145	748	380	1210	175	390	185	710	1046	130	DN50	Rp1 ^{1/4}	Rp3 ⁴ / ₄	180	132
TX N 185	870	1080	1215	190	140	145	828	400	1310	215	210	250	750	981	130	DN65	Rp1 ^{1/2}	Rp3 ⁴ / ₄	180	180
TX N 225	870	1210	1215	190	140	145	828	400	1310	215	340	250	750	1111	130	DN65	Rp1 ^{1/2}	Rp3 ⁴ / ₄	180	180
TX N 300	910	1275	1385	190	140	145	928	440	1485	255	285	315	780	1177	125	DN80	Rp2	Rp3 ⁴ / ₄	225	180
TX N 380	910	1470	1385	190	140	145	928	440	1485	255	480	315	780	1372	125	DN80	Rp2	Rp3 ⁴ / ₄	225	180
TX N 500	920	1605	1645	190	140	170	1028	480	1740	298	435	440	790	1504	130	DN100	DN65	Rp1 ^{1/4}	250	210
TX N 630	920	1800	1645	190	140	170	1028	480	1740	298	630	440	790	1699	130	DN100	DN65	Rp1 ^{1/4}	250	210
TX N 730	920	1995	1645	190	140	170	1028	480	1740	298	825	440	790	1894	130	DN100	DN65	Rp1 ^{1/4}	250	210
TX N 840	1122	2115	1432	190	195	195	1025	480	1540	298	945	440	1020	2014	125	DN100	DN65	Rp1 ^{1/4}	250	270
TX N 1100	1462	2282	1542	190	230	290	1120	565	1650	561	510	550	1360	2176	185	DN150	DN80	Rp1 ^{1/2}	350	270
TX N 1320	1462	2652	1542	190	230	290	1120	565	1650	561	880	550	1360	2546	185	DN150	DN80	Rp1 ^{1/2}	350	270
TX N 1600	1622	2692	1702	190	260	290	1245	605	1810	661	670	700	1520	2590	185	DN175	DN100	Rp1 ^{1/2}	400	285
TX N 1900	1622	3014	1702	190	260	290	1245	605	1810	662	990	700	1520	2910	185	DN175	DN100	Rp1 ^{1/2}	400	285

Unical[®]

